

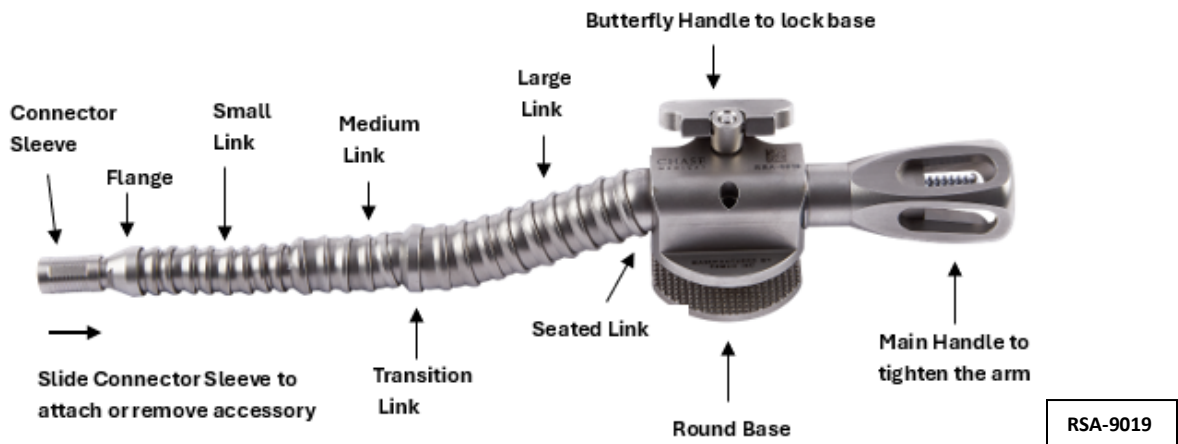

COBRA™ Reusable Surgical Arm, Stainless Steel, Shaft Connect INSTRUCTIONS FOR USE

Product Code	Description
RSA-9016	Cobra Surgical Arm, 16cm Length, Lg/Med/Sm Links, Universal Attachment Base, Shaft Connect
RSA-9019	Cobra Surgical Arm, 19cm Length, Lg/Med/Sm Links, Universal Attachment Base, Shaft Connect
RSA-9119	Cobra Surgical Arm, 19cm Length, All Sm Links, Universal Attachment Base, Shaft Connect



Preventive Maintenance:

To allow for optimum performance, it is recommended that this device be reconditioned based on frequency of use. Frequent use or use of high alkaline detergents may require more frequent reconditioning.

Service:

Chase Medical has the ONLY authorized service center for the COBRA™ Reusable Surgical Arm and uses genuine USA parts. Call 972-783-7005 for return/repair instructions.

Caution:

The COBRA™ Surgical Arm must be thoroughly cleaned, sterilized, and inspected prior to returning for reconditioning.

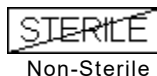



Contents

Preventive Maintenance	1
Service	1
Product Description / Indications for Use	2
General Warnings.....	2
COBRA™ Reusable Surgical Arm Description of Parts.....	3
Pre-Use Inspection	4
Use of Device	5
Cleaning the Device	6
Post Cleaning Inspection	6
Sterilization.....	7
Lubrication.....	7
Warranty.....	7

Product Description / Indications for Use:

The COBRA™ Reusable Surgical Arm is a flexible arm, capable of providing extremely rigid positioning. It is comprised of metal links, an attachment connector, assembly main body for attachment to standard sternotomy retractors or other thoracic access devices, and a handle for tightening. The connector tip can be used with currently available disposable and reusable stabilization and retraction devices.

General Warnings:

- Excessive torque may cause cables to fray, snap, or break.
- **If the arm does not hold position, do not use, contact CHASE MEDICAL for repair instructions.**
- Avoid repositioning the arm when the arm is tightened. It will cause unnecessary wear on the cable and may cause it to fray and possibly break.
- Heavy use of devices or use of high alkaline detergents may require more frequent service.
- Inspect for cable fray visually only. Do not use fingers to check for cable fray.

COBRA™ Reusable Surgical Arm Description of Parts

RSA-9016 (16cm Length) and RSA-9019, RSA-9119 (19cm Length)

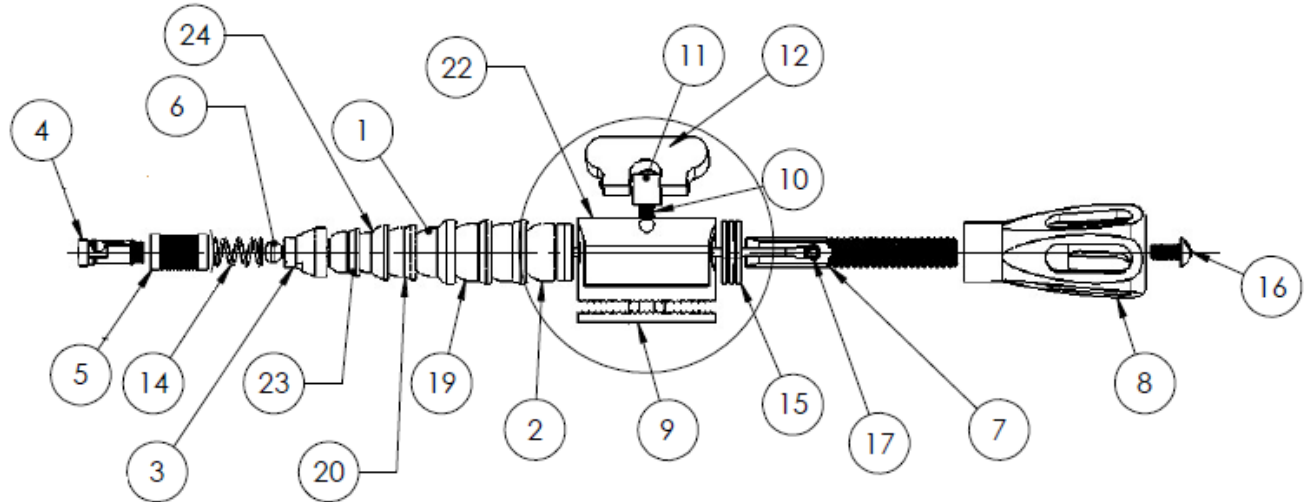

<u>Item</u>	<u>Part Description</u>
1	TRANSITION LINK, LARGE TO MED
2	SOLID LINK
3	CONNECTOR FLANGED ADAPTOR
4	CONNECTOR COLLET
5	CONNECTOR SLEEVE
6	CABLE ASSEMBLY
7	LOCKING STUD
8	LOCKING HANDLE
9	LOWER BODY WELDMENT
10	CLAMP SCREW
11	CLAMP SCREW COLLAR
12	BUTTERFLY HANDLE
14	SPRING
15	THRUST BEARING
16	TRUSS HEAD SLOTTED MACHINE SCREW
17	FLAT POINT SET SCREW
19	LARGE LINKS
20	MEDIUM LINKS
22	BODY ASSEMBLY
23	SMALL LINKS

Links quantities:			
Links Type	RSA-9016	RSA-9019	RSA-9119
Large	9	9	2
Lg to Med Transition	1	1	0
Lg to Sm Transition	0	0	1
Medium	4	4	0
Med to Sm Transition	1	1	0
Small	4	8	23

Pre-Use Inspection:

Prior to use, the unit should be fully loosened and visually inspected. The cable should be inspected by examining the spaces between links. No signs of wear or fraying of the cable should be present. **If any wear is found, do not use, and contact CHASE MEDICAL for return/repair instructions.**

Key Areas to Inspect:

- Loosen the arm completely with the main handle. Check the space between the first link and the body as shown in FIGURES 1 and 2.



FIGURE 1. Frayed cable.
DO NOT USE



FIGURE 2. Good Cable

- Dangle the arm from the body. The cable/Links should hang relatively straight with only a slight curve. Inspect the space between every link and its neighbor, including the space between the most distal link and the connector. (FIGURE 3) A cable fails due to wear of the cable within the Links. Each cable failure is a gradual event that occurs over many tightening cycles. As the cable begins to fail, the outer strands will break and begin to fray. **DO NOT USE the arm if there is any sign of fraying.**
- Verify function of the device by tightening and loosening the cable using the main handle. NOTE: It should only take a maximum of one rotation of the handle to fully tighten the arm once the slack has been removed. The arm should be able to hold its weight horizontally. (FIGURE 4).



FIGURE 3. Completely loosen the arm with the main handle and dangle. Check for cable fray between every link.



FIGURE 4. Tightened arm should hold its own weight from the distal end.

Use of Device:

1. The COBRA™ Reusable Surgical Arm is a reusable flexible arm, capable of providing extremely rigid positioning. It is comprised of 3 sizes of metal links, an attachment connector, a main handle for tightening, and a body assembly for attachment to standard sternotomy retractors or other thoracic access devices. The connector tip can be used with currently available disposable and reusable stabilization and retraction devices.
2. To attach an accessory device (e.g., an atrial rake or heart assist finger) to the connector sleeve, slide and hold the spring-loaded sleeve back towards the arm. (FIGURE 5) Insert the shaft into the connector sleeve **with the detent on the shaft facing the flat on the connector sleeve**. Release sleeve and check for secure connection. The sleeve must be completely forward and flush with connector. (FIGURE 6) Once locked, the attachment is ready for use.
3. Attach the body of the COBRA™ Reusable Surgical Arm to sternotomy retractor or other access device. Turn butterfly handle clockwise to affix clamp to retractor or access device. Position accessory as required. Turn the main handle clockwise until the arm is stable. Do not over tighten.

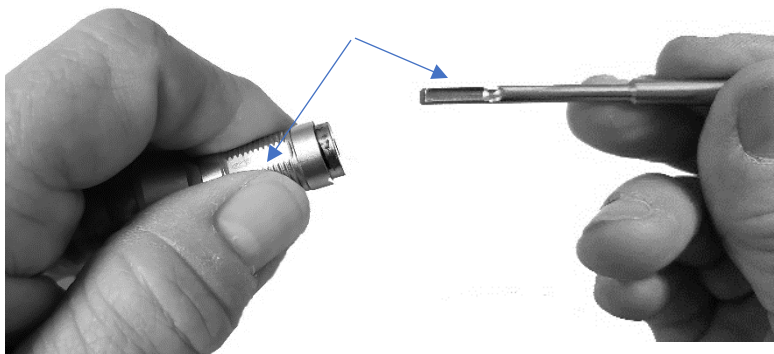

FIGURE 5

With the sleeve pulled back, insert the shaft into the connector sleeve, aligning the detent on the shaft with the flat on the sleeve.



FIGURE 6

The sleeve will be flush when the attachment is locked.



4. Do not reposition the arm without loosening the arm.

- a) When making major adjustments in the positioning of the flexible arm, loosen the knob until the flexible arm becomes limp, reposition, and then tighten.
- b) When making minor adjustments in the positioning of the flexible arm, loosen the adjustment knob slightly. Retighten knob after the adjustment has been made.
- c) Keep the arm loose when not in use.

Caution:

Forcing the tightened arm to move against its present position will cause the cable in the flexible arm to wear and possibly break. After doing this over a period of time, there may be drifting in arm position even though the main handle is tight.

The arm should never be overtightened - a maximum of one full turn once the arm is stable is sufficient.

Cleaning the Device:

Completely loosen the arm. Remove the attachment. Links may bind from tightening compression. Separate links by light tapping with a plastic handle. Remove all traces of blood and debris. Manually scrub each link thoroughly using a soft brush or lint-free cloth and recommended enzymatic cleaner. Make sure all moving parts are cleaned thoroughly to prevent debris from interfering with movement. After manual cleaning, rinse the arm completely with purified water running between each link to remove all signs of enzymatic cleaner.

Incomplete rinsing after cleaning can cause enzymatic cleaner to form a residue on the arm that may result in links binding.

Post Cleaning Inspection:

Visually inspect the entire arm (i.e., surface, links, joints, body assembly, main handle, cable, etc.), for cleanliness to assure all residue has been removed. After cleaning completely dry the arm for a minimum thirty minutes before storage and use.

A visual inspection should be conducted between every link from the body assembly to the connector tip for cable fray.

Caution:

There should be no signs of wear or fraying of the cable. If some wear is observed, immediately return the arm for repair.



Sterilization:

After following the cleaning recommendations, the device may be sterilized using the following processing parameters.

Ensure the Arm is not tightened during sterilization. Keep it loose when not in use.

To monitor the effectiveness of the sterilization process, a biological indicator containing *Geobacillus stearothermophilus* spores may be used.

Steam Sterilizer	Temperature	Time	Drying Time
Pre-vacuum (Wrapped)	132°C (270°F)	4 minutes	30 minutes
Gravity Displacement (Wrapped)	121°C (250°F)	30 minutes	30 minutes

Lubrication:

Lubrication on the screw is not required for every use. A water-soluble, biodegradable grade is recommended. Turn the handle all the way back to expose the screw. Apply an approved instrument lubricant on the thread portion of the screw. This will increase the life of the device.

Warranty:

Reprocessed Products

Chase Medical warrants all reprocessed products, subject to the exceptions provided herein, to be free from defects in reprocessing and to substantially conform to the product specifications contained in the documentation provided by Chase Medical in accordance with the instructions for use of such product.

CHASE MEDICAL SHALL NOT BE LIABLE FOR ANY DAMAGES TO THE EXTENT CAUSED BY ANY DEFECT IN MATERIAL, WORKMANSHIP OR DESIGN BY THE ORIGINAL MANUFACTURER OF THE PRODUCT OR ANY ACT OR OMISSION OF THE ORIGINAL MANUFACTURER OF THE PRODUCT.

Original Manufacturer

Chase Medical warrants all products it represents from the original manufacturer, subject to the exceptions provided herein, to be free from defects in design, materials and workmanship and to substantially conform to the product specifications contained in the documentation provided by Chase Medical with the products for a period of one year from the date of purchase.

General Warranty Terms Applicable to All Products

TO THE FULLEST EXTENT PERMITTED BY LAW, THE EXPRESS WARRANTY SET FORTH HEREIN IS THE ONLY WARRANTY APPLICABLE TO THE PRODUCTS AND IS EXPRESSLY IN LIEU OF ANY OTHER WARRANTY BY CHASE MEDICAL, EXPRESSED OR IMPLIED, INCLUDING, BUT NOT LIMITED TO, ANY IMPLIED WARRANTY OR MERCHANTABILITY OR FITNESS FOR A PARTICULAR PURPOSE. IN NO EVENT WILL CHASE MEDICAL'S LIABILITY



ARISING IN CONNECTION WITH THE SALE OF THE PRODUCT (WHETHER UNDER THE THEORIES OF BREACH OF CONTRACT, TORT, MISREPRESENTATION, FRAUD, WARRANTY, NEGLIGENCE, STRICT LIABILITY OR ANY OTHER THEORY OF LAW) EXCEED THE PURCHASE PRICE, CURRENT MARKET VALUE OR RESIDUAL VALUE OF THE PRODUCTS, WHICHEVER IS LESS. CHASE MEDICAL SHALL NOT BE LIABLE FOR INDIRECT, SPECIAL, INCIDENTAL, PUNITIVE OR CONSEQUENTIAL DAMAGES RESULTING FROM ANY BREACH OF WARRANTY OR UNDER ANY OTHER LEGAL THEORY.

This warranty shall apply only to the original end-user purchaser of products directly from Chase Medical or a Chase Medical authorized distributor. This warranty may not be transferred or assigned without the express written consent of Chase Medical.

This warranty does not apply to:

- (1) products that have been misused, neglected, modified, altered, adjusted, tampered with, improperly installed or refurbished;
- (2) products that have been repaired by any person other than Chase Medical's designated source without the prior written consent of Chase Medical;
- (3) products that have been subjected to unusual stress or have not been maintained in accordance with the instructions in this IFU or as demonstrated by a Chase Medical representative.
- (4) products on which any original serial numbers or other identification marks have been removed or destroyed; or
- (5) products that have been repaired with any unauthorized or non-Chase Medical components.

If a valid warranty claim is received within thirty (30) days of the expiration of the applicable warranty period, Chase Medical will, in its sole discretion:





- (1) replace the product at no charge with a product that is at least functionally equivalent to the original product or
- (2) refund the purchase price of the product. If a refund is provided by Chase Medical, the product for which the refund is provided must be returned to Chase Medical and will become Chase Medical's property.

In any event, Chase Medical's liability for breach of warranty shall be limited to the replacement value of the defective or non-conforming part or component. If Chase Medical determines in its reasonable discretion that the claimed defect or non-conformance in the product is excluded from warranty coverage as described hereunder, it will notify the customer of such determination and will provide an estimate of the cost of repair of the product.

Products and product components repaired or replaced under this warranty continue to be warranted as described herein during the initial applicable warranty period or, if the initial warranty period has expired by the time the product is repaired or replaced, for thirty (30) days after delivery of the repaired or replaced product. When a product or component is replaced, the item provided in replacement will be the customer's property and the replaced item will be Chase Medical's property. If a refund is provided by Chase Medical, the product for which the refund is provided must be returned to Chase Medical and will become Chase Medical's property.



Explanation of Symbols on Packaging Label

	SKU / Catalog Number		Serial Number
	Non-sterile		Consult Electronic Instructions for Use

Manufactured for:



800 E. Campbell Rd.
Suite 252
Richardson, Texas 75081 USA

Tel: (972) 783-7005
Fax: (844) 272-6624
info@chasemedical.com
<https://chasemedical.com/IFU>